

USER GUIDE FOR LED LENS/SOFT PANEL

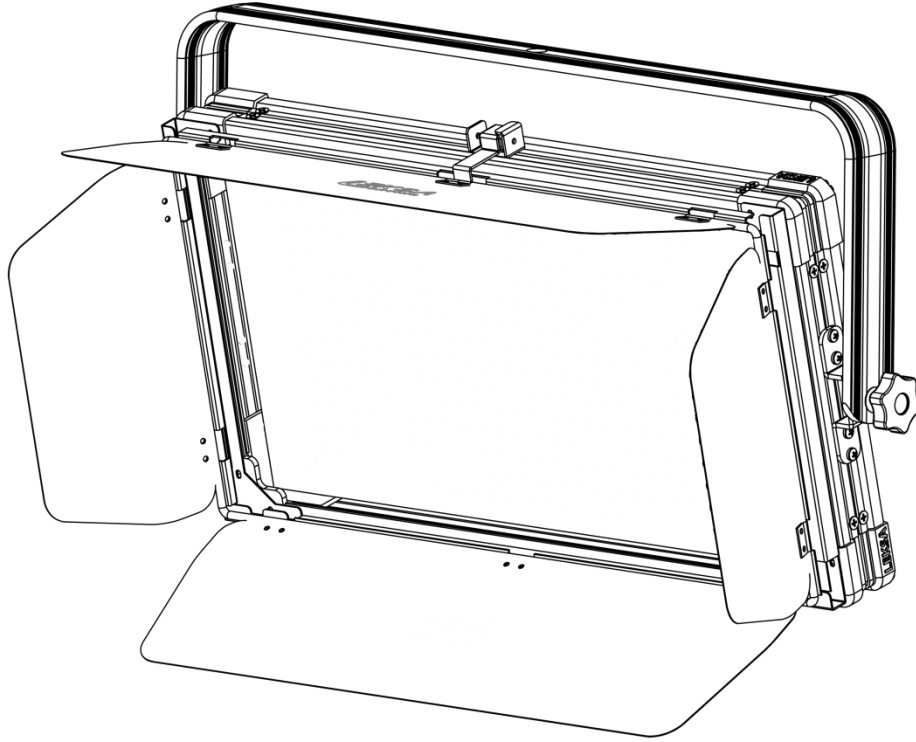

Applicable Models:

LENS/SOFT PANEL – 100W

LENS/SOFT PANEL – 150W

LENS/SOFT PANEL – 200W

LENS/SOFT PANEL – 250W

LENS/SOFT PANEL – 300W

Leksa Lighting® all rights reserved, Information, Specifications, Images and Instructions given in the document herein subject to change without further notice. Leksa Lighting Logo, Data and Indicated product names, Model no's herein the trademarks of Leksa Lighting.

You may connect to below contact for your queries:

📍 Leksa Lighting Technologies Pvt. Ltd
Ashwathpura Road, Mangalore – 574227, India

✉ biz@leksalighting.com

🌐 www.leksalighting.com

☎ +91-7899 – 543210

For Quality and Service support reach us @ quality@leksalighting.com

Important Notice:

There are no user serviceable parts inside the fixture. Do not attempt any repairs yourself; doing so will cease the manufacturing warranty and such acts will void the manufacturer warranty claims.

- Warranty claims to be reported to the above referred email ID's with the product Sl. Nos.
- Warranty will not be extended on the glass and breakable items like lenses etc.
- Product warranty does not cover the physical damages, breakages etc.
- Product warranty ceases if the product is not used as per manufacturer instructions.
- Product warranty is limited to the functional aspects of the fixture.
- Repair or Replacement is depending on the variance of complaint subject to manufacturer decision.

Instructions:

This Product is IP20 rated. For proper operation, follow the **Installation guidelines described in this manual. Only qualified and** certified personnel should perform the installation and only the original rigging parts (brackets, holders, clamps, safety cables) included with this fixture should be used for installation. Any modifications will void the original manufactures warranty and increase the risk of damage and/or personal injury.

- Never look directly into the light source to prevent risk of injury to your retina, which may induce blindness. Those suffering from EPILEPSY should avoid looking directly into the light source of this unit at all times.
- The fan and air inlets must remain clean and never blocked. Allow approx. 6" (15cm) between this fixture and other devices or a wall for proper cooling.
- Always disconnect from main power source before performing any type of service and/or cleaning procedure. Only handle the power cord by the plug end, never pull by tugging the wire portion of the cord.
- Do NOT operate fixture if the power cord has become frayed, crimped and/or damaged. If the power cord is damaged, replace it immediately with a new one of similar power rating.
- Do NOT operate fixture near any flammable materials.
- Do NOT operate fixture in dusty environments.
- Fixture is IP20 rated and should be operated at the dry spaces. Fixture may get damaged to moistures and wet environments.
- This fixture has an inbuilt signal dimming system. Do NOT connect this fixture for external dimmer packs.
- We urge you to ensure proper mechanical fitments of clamps and a usage of safety chains while suspending from the top.

FIXTURE OVERVIEW:

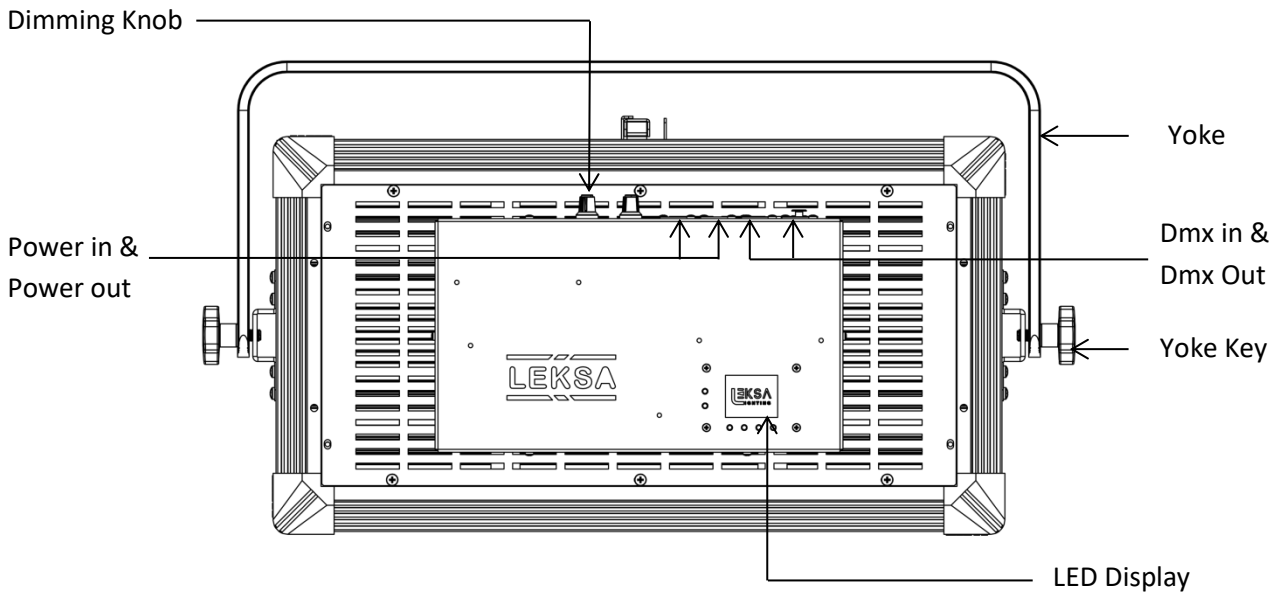

DMX Input
5 Pin XLR Socket

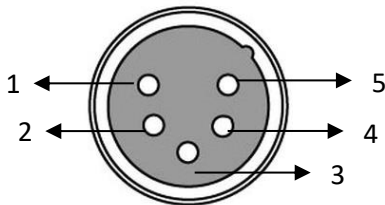

DMX Output
5 Pin XLR Socket

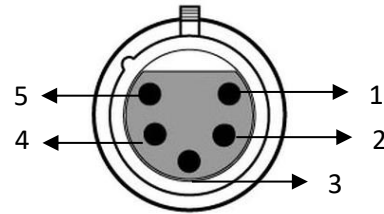

1	Ground	2	Data -	3	Data +
4	Open	5	Open		

Note:

- DMX 512 Signal looping can be done from one fixture to other.
- Maximum 25 to 30 Fixtures can be taken in a single loop provided the distance is within short range.
- No Y Split is allowed for DMX looping.
- DMX last open end to be terminated with a 120 Ohm Resistor termination plug

FIXTURE DETAILS:

Type of Fixture	:	LED LENS/SOFT PANEL
Lamp Source	:	Light Emitting Diode (LED)
Input Voltage	:	110-240V, 50-60Hz
Power Consumptions :		LED LENS/SOFT PANEL – 100W & 150W LED LENS/SOFT PANEL – 200W & 250W LED LENS/SOFT PANEL – 300W
Control Modes	:	Manual Dimming/DMX Dimming
Power Chord	:	Neutrik Power In & Loop
DMX Interface	:	5 Pin (Standard), 3 Pin (Custom)
Dimensions	:	

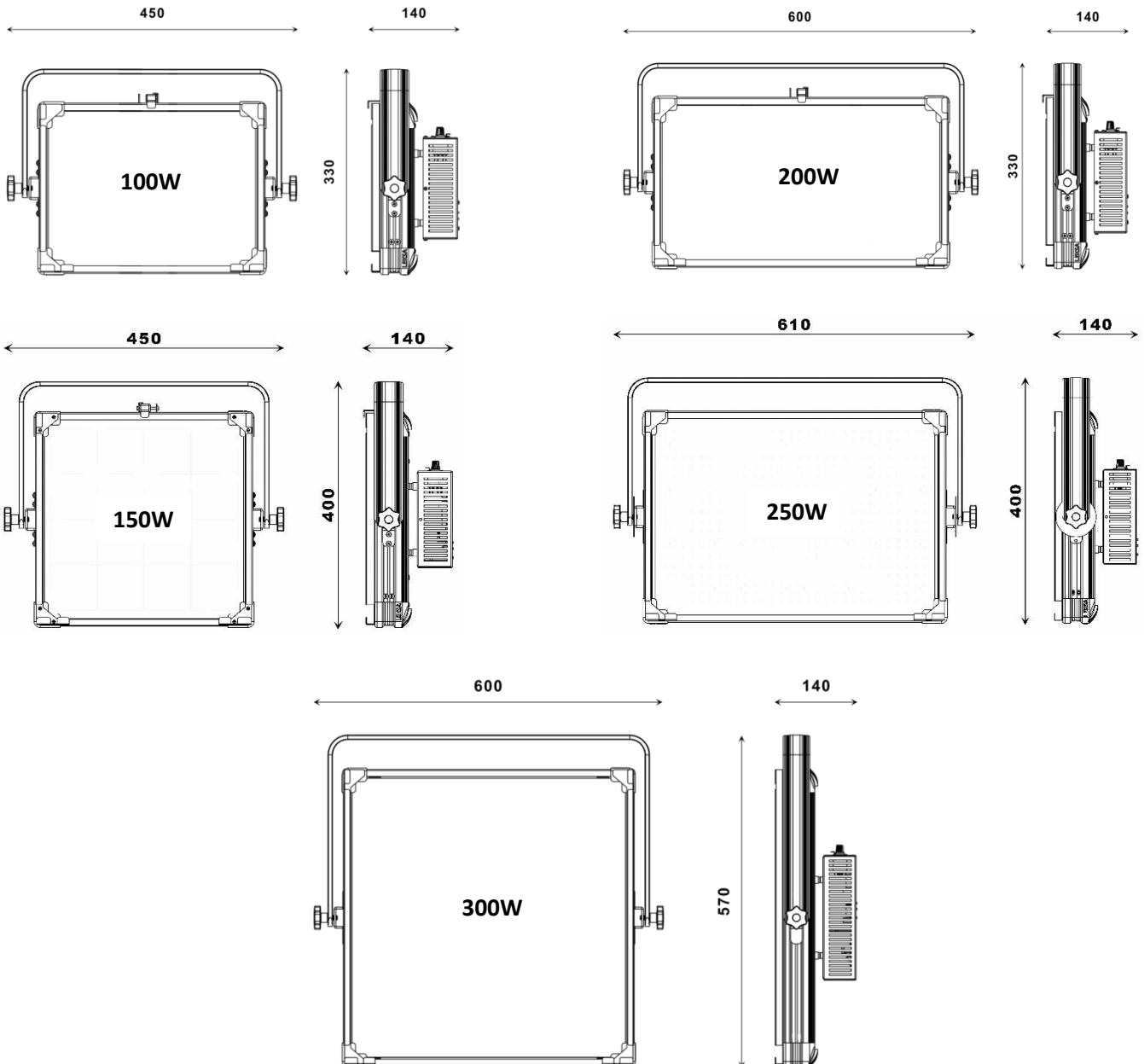

FIXTURE OPERATION:

- Unbox the fixture and connect Power Neutrik inlet connector to the fixture to power UP.
- There are 4 Switches – Menu, Up, Down, Enter,

in menu		TOO
DMX - Addr	512	
Rotary - ADJ	-->	
Key - ADJ	-->	
DMX Keep	OFF	
Display Rotate	OFF	
PW	<input type="text"/>	0%

- Selected Row is highlighted with Yellow and by pressing Enter you may edit the values. While Enter is pressed, editing mode Row is highlighted with Green as below.

in menu		TOO
DMX - Addr	512	
Rotary - ADJ	-->	
Key - ADJ	-->	
DMX Keep	OFF	
Display Rotate	OFF	
PW	<input type="text"/>	0%

- Menu button will be used for back operation to exit the editing mode or come back to the main Menu.
- Up & Down Keys will help you to navigate to reach other options in the menu bar.

DMX _ Address	-	To set the DmX Address.
Rotary Adjustment	-	To change the intensities quickly in Live Mode
Key Adjustment	-	Fixture Setting to Manual Dimming Mode
DmX Keep	-	To hold the last value of output on failure of DmX
Display Rotate	-	To rotate the display when fixture is tilted 180°

DMX Operation:

DmX Address Setting:

- Enter the Menu button and navigate the selection to 'DMX - Addr' and press Enter.
- Your selection will change to Green as below.

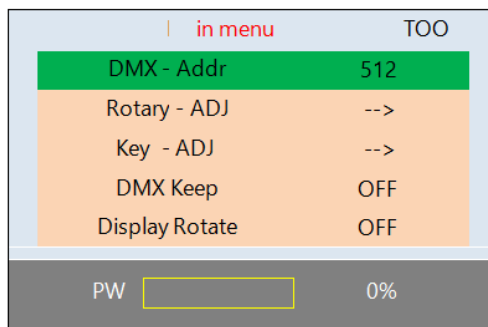

- Use UP & Down Keys to adjust the DmX Address. You may set the DmX Address between 1 ~ 512 as per DmX Protocol
- After the address setting press Enter to save the value. Your display row will change the color to Yellow again as a indication of data saving. Even though a power failure after saving the address, light will retain the DmX address when it is powered up.
- You will be able to operate the light at the set address by connecting the fixture to the DmX network.
- User is requested to follow the basic Notes provided in Page No. 4 regarding DmX.

Manual Light Control:

- Enter the Menu button and navigate the selection to Key Adjustment and press Enter.
- Your selection will change to Green as below

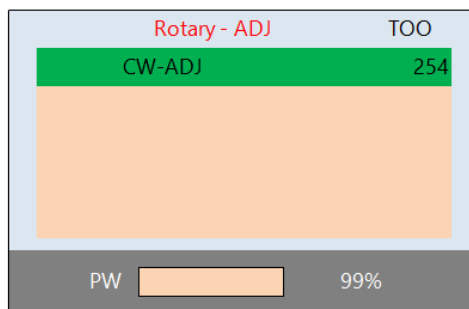

- Use UP & down Keys to adjust the intensities. Values of the light will vary proportionately 0 ~ 100% by adjusting the values from 0 ~ 255.
- After the value setting press Enter to save the value. Your display row will change the color to Yellow again as a indication of data saving. Even though a power failure after saving the value, light will retain the values when it is powered up.

Note:

- In a DmX Mode, Light fixture will operate with 1 Channel. For a Bi Color Fixture 2 Channels will be utilized.
- CW – Stands for Cool White 5600K, WW – Stands for Warm White 3200K.
- Do NOT open the fixture for any kind of repair. There are parts which can be operated by authorized personnel's only.

For Further assistance, you are requested to contact our office or authorized dealers.
We are there at your service.

Thank You for Choosing Leksa Lighting:

Leksa Lighting Technologies Pvt. Ltd.
Ashwathapura Road, Moodbidri,
Mangalore – 574227, India
www.leksalighting.com
biz@leksalighting.com
+91-7899 543210