

## USER GUIDE FOR LED BLINDER SERIES

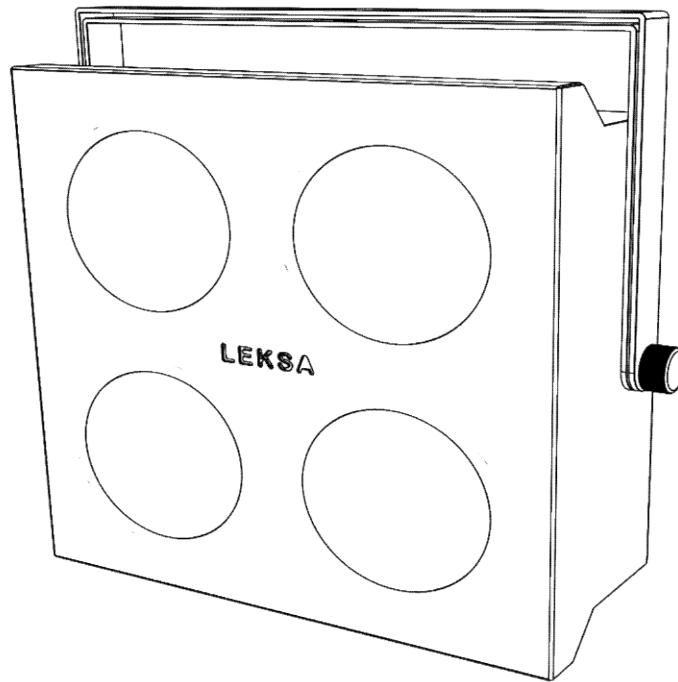

Applicable Models:

LK BLDR 2100 T/D - 200W

LK BLDR 4100 T/D – 400W

T – Tungsten 3200K

D – Daylight 5600K

BC – Bi-Colour 3200K ~ 5600K

User manual V 1.0

Leksa Lighting® all rights reserved. Information, Specifications, Images and Instructions given in the document herein subject to change without further notice. Leksa Lighting Logo, Data and Indicated product names, Model no's herein the trade marks of Leksa Lighting.

You may connect to below contact for your queries:

 Leksa Lighting Technologies Pvt. Ltd

Ashwathpura Road, Mangalore – 574227, India

 [biz@leksalighting.com](mailto:biz@leksalighting.com)  [www.leksalighting.com](http://www.leksalighting.com)

 +91-7899 – 543210

For Quality and Service support reach us @ [quality@leksalighting.com](mailto:quality@leksalighting.com)

### **Important Notice:**

There are no user serviceable parts inside the fixture. Do not attempt any repairs yourself; doing so will cease the manufacturing warranty and such acts will void the manufacturer warranty claims.

- Warranty claims to be reported to the above referred email ID's with the product SI Nos.
- Warranty will not be extended on the glass and breakable items like lenses etc.
- Product warranty does not cover the physical damages, breakages etc.
- Product warranty ceases if the product is not used as per manufacturer instructions.
- Product warranty is limited to the functional aspects of the fixture.
- Repair or Replacement is depend on the variance of complaint subject to manufacturer decision.

## Instructions:

This Product is IP20 rated. For proper operation, follow the **Installation guidelines described in this manual. Only qualified and** certified personnel should perform the installation and only the original rigging parts (brackets, holders, clamps, safety cables) included with this fixture should be used for installation. Any modifications will void the original manufactures warranty and increase the risk of damage and/or personal injury.

- Never look directly into the light source to prevent risk of injury to your retina, which may induce blindness. Those suffering from EPILEPSY should avoid looking directly into the light source of this unit at all times.
- The fan and air inlets must remain clean and never blocked. Allow approx. 6" (15cm) between this fixture and other devices or a wall for proper cooling.
- Always disconnect from main power source before performing any type of service and/or cleaning procedure. Only handle the power cord by the plug end, never pull by tugging the wire portion of the cord.
- Do NOT operate fixture if the power cord has become frayed, crimped and/or damaged. If the power cord is damaged, replace it immediately with a new one of similar power rating.
- Do NOT operate fixture near any flammable materials.
- Do NOT operate fixture in dusty environments.
- Fixture is IP20 rated and should be operated at the dry spaces. Fixture may get damaged to moistures and wet environments.
- This fixture has a inbuilt signal dimming system. Do NOT connect this fixtures for external dimmer packs.
- We urge you to ensure proper mechanical fitments of clamps and a usage of safety chains while suspending from the top.

## FIXTURE OVERVIEW:

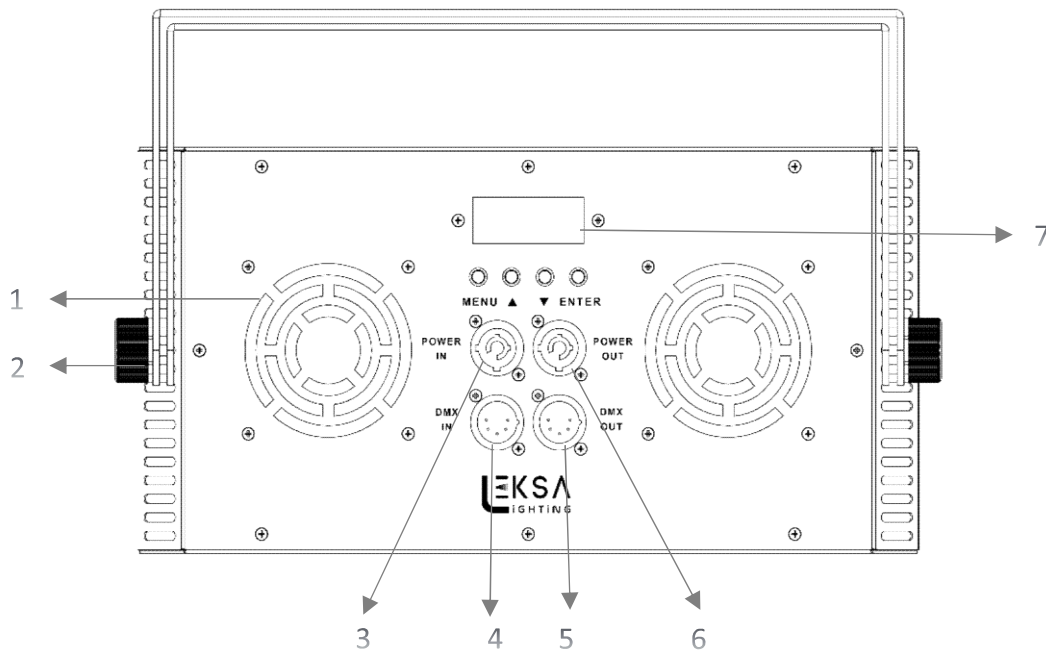

1	Intake Fan	2	Knob	3	Power In
4	DmX In	5	DmX Out	6	Power Out
		7	7 Segment Display		

DmX Input  
5 Pin XLR Socket

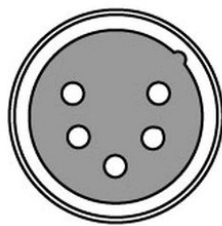

DmX Output<sub>3</sub>  
5 Pin XLR Socket

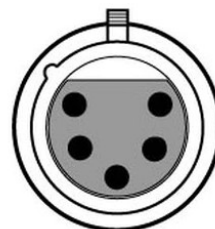

1: Ground **Note:**

2: Data (-)

3: Data (+)

4: Open

5: Open

- DmX 512 Signal looping can be done from One fixture to other.
- Maximum 25 to 30 Fixtures can be taken in a single loop provided the distance is within short range.
- No Y Split is allowed for DmX looping.
- DmX last open end to be terminated with a 120 Ohm Resistor termination plug.

## FIXTURE DETAILS:

Type of Fixture	:	LED Blinder Light
Lamp Source	:	Light Emitting Diode (LED)
Power Consumptions	:	LK BLDR 4100 T/D : 400W LK BLDR 2100 T/D : 200W
Control Modes	:	Manual Dimming/ DMX Dimming
Power Chord	:	Neutrik Power In & Loop
DmX Interface	:	5 Pin (Std), 3 Pin (Custom)
Dimensions	:	

### 200W LED Blinder Light :

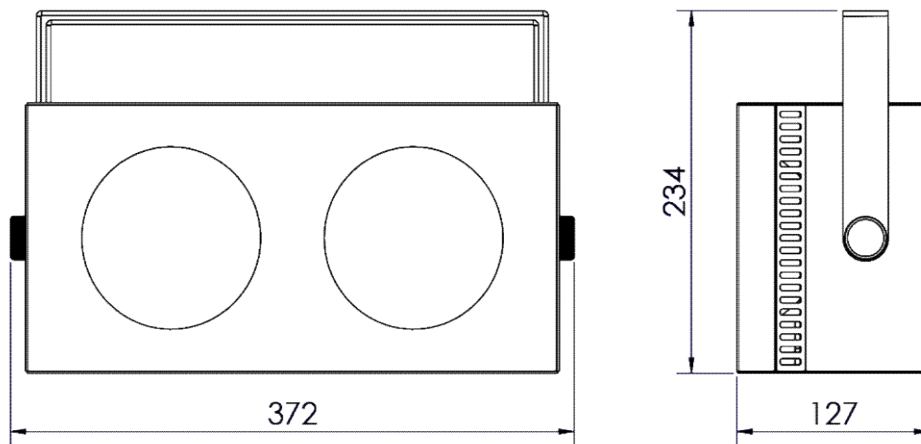

### 400W LED Blinder Light :

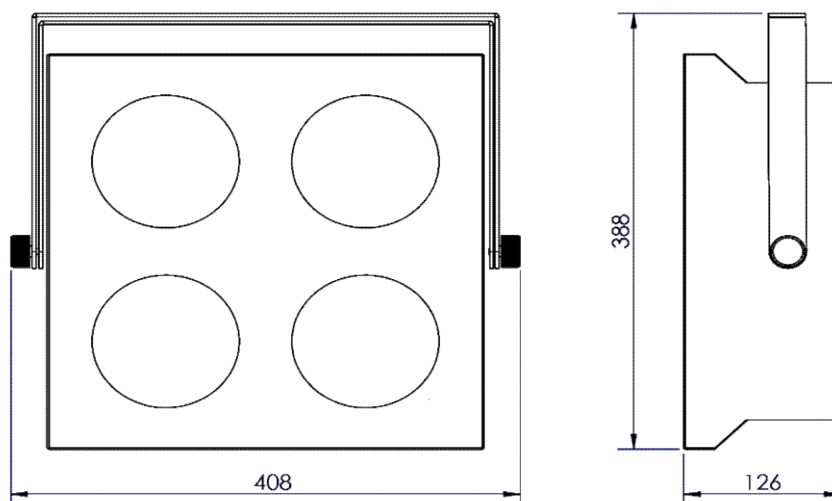

## FIXTURE OPERATION:

- Unbox the fixture and connect Power Neutrik inlet connector to the fixture to power UP.
- There are 4 Switches – Menu, Up, Down, Enter,

Button	Function
<Menu>	Used to scroll through the current operating mode, as well as back out of the current menu option.
<UP>	Used to select an increasing value.
<DOWN>	Used to select a decreasing value.
<ENTER>	Used to activate a selection and store it to memory.

## DMX Operation:

This operating mode will allow for control with an external DMX controller. You must set the starting address for this mode.

Please see the instructions below for details on this mode.

- Plug the fixture into power.
- Plug a DMX controller into the fixture in a daisy chain configuration.
- Press <Menu> until Address appears on the LED screen.

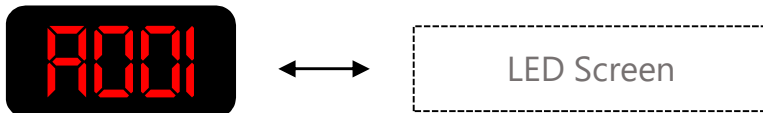

- Press <ENTER>
- Using <UP> & <DOWN>, select the DMX starting address.
- Press <ENTER>.

## DMX Channel Values :

CH	Function
1	Dimmer
2	Led 1
3	Led 2
4	Led 3
5	Led 4
6	Dimmer
7	Strobe
8	Dimmer speed and Sound

**MANUAL OPERATION:**

- All the function can be selected and press "Enter" to confirm.

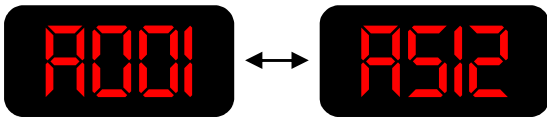

8 Channel DMX address. **A001** indicates 0% light intensity and **A512** indicates 100% light intensity. Use "ΛV" key to select the required light intensity.

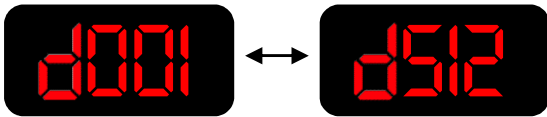

4 Channel DMX address. **d001** indicates 0% light intensity and **d512** indicates 100% light intensity. Use "ΛV" key to select the required light intensity.

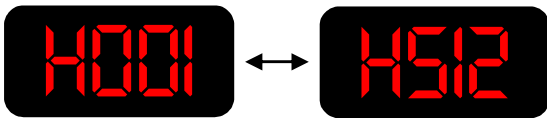

2 Channel DMX address. **H001** indicates 0% light intensity and **H512** indicates 100% light intensity. Use "ΛV" key to select the required light intensity.

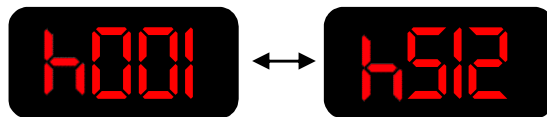

1 Channel DMX address. **h001** indicates 0% light intensity and **h512** indicates 100% light intensity. Use "ΛV" key to select the required light intensity.

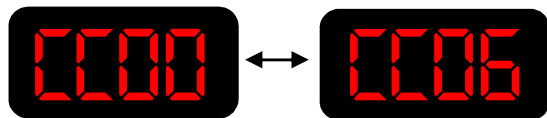

Running pattern, **CC00** indicates 0% Running pattern and **CC06** indicates 100% Running pattern. Use "ΛV" key to select the required Running pattern intensity.

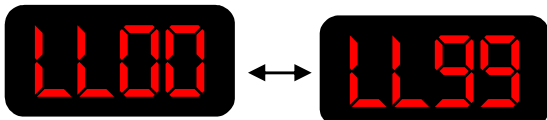

Jumping speed, **LL00** indicates 0% Jumping speed and **LL99** indicates 100% Jumping speed. Use "ΛV" to revise jumping speed.

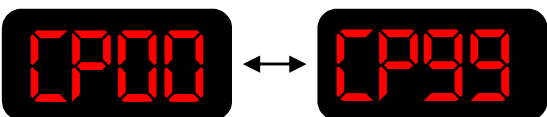

Gradual change, **CP00** indicates 0% Gradual change speed and **CP99** indicates 100% Gradual change speed. Use "ΛV" key to revise Gradual change speed.

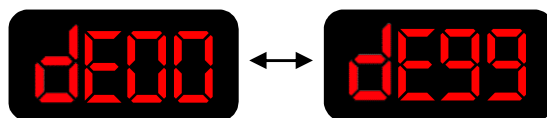

Pulse. **dE00** indicates 0% Pulse change of the composite and **dE99** indicates 100% Pulse change of the composite. Use "ΛV" key to revise speed of the composite.



It indicates sound mode. The light will flicker according to the music beat.

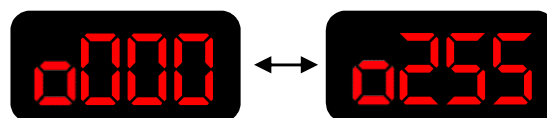

Choose White color, **o000** indicates zero percent light intensity and **o255** indicates 100% indicates zero percent light intensity. Use "ΛV" key to revise the choice of color.

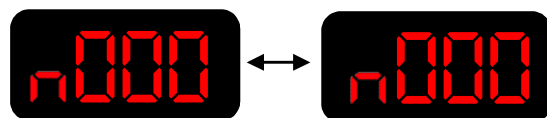

Strobe, **Y000** indicates 0% Strobe and **F255** indicates 100% Strobe, Use "ΛV" key to revise strobe speed.

**DMX Channel**
**DMX512 8 Channel description**

No	Function	Description
CH1	Master Dimming	W1,W2,W3,W4 master dimming, linear dimming, from dark to bright.
CH2	W1 Dimming	W1 Dimming, linear dimming, from dark to bright.
CH3	W2 Dimming	W2 Dimming, linear dimming, from dark to bright.
CH4	W3 Dimming	W3 Dimming, linear dimming, from dark to bright.
CH5	W4 Dimming	W4 Dimming, linear dimming, from dark to bright.
CH6	Master Strobe	W1,W2,W3,W4 master strobe,from dark to bright.
CH7	Select function	0-20 : Empty, 21-35 : Jump to run 1, 121-135 : Jump to run 6, 136-150 : Gradual to run 1, 226-240 : Gradual to run 6, 241-255 : Sound activated
CH8	Function Speed	Function speed, from slow to fast.

**DMX512 4 Channel description**

No	Function	Description
CH1	W1 Dimming	W1 Dimming, linear dimming, from dark to bright.
CH2	W2 Dimming	W2 Dimming, linear dimming, from dark to bright.
CH3	W3 Dimming	W3 Dimming, linear dimming, from dark to bright.
CH4	W4 Dimming	W4 Dimming, linear dimming, from dark to bright.
CH8	Function Speed	Function speed, from slow to fast.

**DMX512 2 Channel description**

No	Function	Description
CH1	Master Dimming	W1,W2,W3,W4 master dimming, linear dimming, from dark to bright.
CH2	Master Strobe	W1,W2,W3,W4 master strobe,from dark to bright.

**DMX512 1 Channel description**

No	Function	Description
CH1	Master Dimming	W1,W2,W3,W4 master dimming, linear dimming, from dark to bright.

**Note:**

- In a DmX Mode, Light fixture will operate with 8 Channel.
- CW – Stands for Cool White 5600K, WW – Stands for Warm White 3200K.
- Do NOT open the fixture for any kind of repair. There are parts which can be operated by authorized personnel's Only.

For Further assistance, you are requested to contact our office or authorized dealers.

We are there at your service.

Thank You for Choosing Leksa Lighting:

Leksa Lighting Technologies Pvt. Ltd.

Ashwathapura Road, Mangaore – 574227, India

[www.leksalighting.com](http://www.leksalighting.com) [biz@leksalighting.com](mailto:biz@leksalighting.com) +91-7899 543210