

## **USER GUIDE FOR LED LENS/SOFT PANEL**

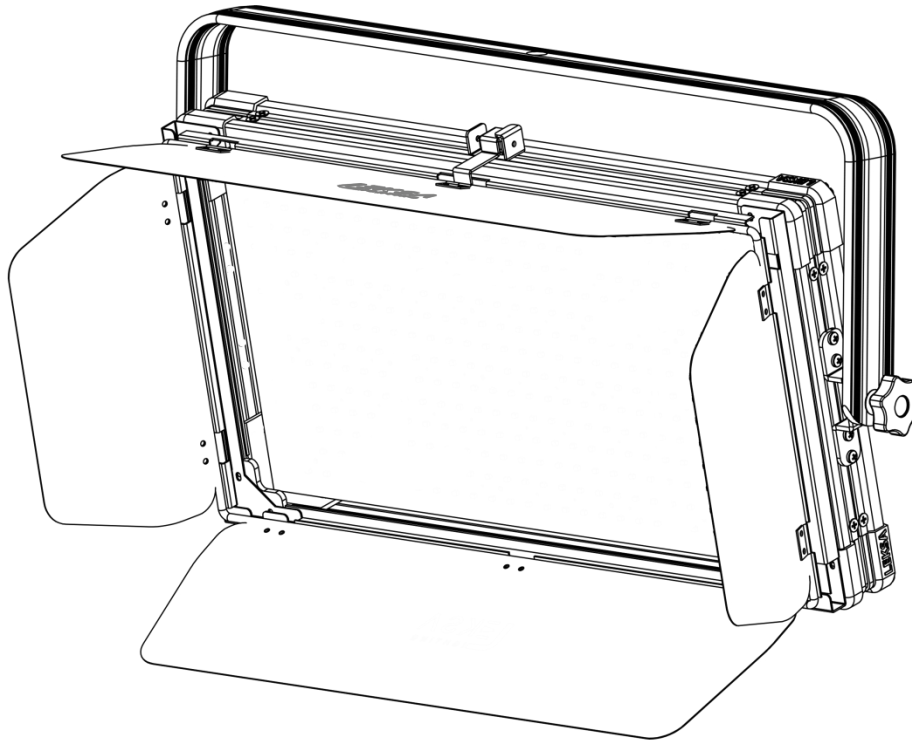

### **Applicable Models:**

LENS/SOFT PANEL(T/D/BC) – 100W

LENS/SOFT PANEL(T/D/BC) – 150W

LENS/SOFT PANEL(T/D/BC) – 200W

LENS/SOFT PANEL(T/D/BC) – 250W

LENS/SOFT PANEL(T/D/BC) – 300W

Leksa Lighting® all rights reserved, Information, Specifications, Images and Instructions given in the document herein subject to change without further notice. Leksa Lighting Logo, Data and Indicated product names, Model no's herein the trademarks of Leksa Lighting.

You may connect to below contact for your queries:

- 📍 Leksa Lighting Technologies Pvt. Ltd  
Ashwathpura Road, Mangalore – 574227, India
- ✉ [biz@leksalighting.com](mailto:biz@leksalighting.com)
- 🌐 [www.leksalighting.com](http://www.leksalighting.com)
- ☎ +91-7899 – 543210

For Quality and Service support reach us @ [quality@leksalighting.com](mailto:quality@leksalighting.com)

### **Important Notice:**

There are no user serviceable parts inside the fixture. Do not attempt any repairs yourself; doing so will cease the manufacturing warranty and such acts will void the manufacturer warranty claims.

- Warranty claims to be reported to the above referred email ID's with the product Sl. Nos.
- Warranty will not be extended on the glass and breakable items like lenses etc.
- Product warranty does not cover the physical damages, breakages etc.
- Product warranty ceases if the product is not used as per manufacturer instructions.
- Product warranty is limited to the functional aspects of the fixture.
- Repair or Replacement is depending on the variance of complaint subject to manufacturer decision.

## Instructions:

This Product is IP20 rated. For proper operation, follow the **Installation guidelines described in this manual. Only qualified and** certified personnel should perform the installation and only the original rigging parts (brackets, holders, clamps, safety cables) included with this fixture should be used for installation. Any modifications will void the original manufactures warranty and increase the risk of damage and/or personal injury.

- Never look directly into the light source to prevent risk of injury to your retina, which may induce blindness. Those suffering from EPILEPSY should avoid looking directly into the light source of this unit at all times.
- The fan and air inlets must remain clean and never blocked. Allow approx. 6" (15cm) between this fixture and other devices or a wall for proper cooling.
- Always disconnect from main power source before performing any type of service and/or cleaning procedure. Only handle the power cord by the plug end, never pull by tugging the wire portion of the cord.
- Do NOT operate fixture if the power cord has become frayed, crimped and/or damaged. If the power cord is damaged, replace it immediately with a new one of similar power rating.
- Do NOT operate fixture near any flammable materials.
- Do NOT operate fixture in dusty environments.
- Fixture is IP20 rated and should be operated at the dry spaces. Fixture may get damaged to moistures and wet environments.
- This fixture has an inbuilt signal dimming system. Do NOT connect this fixture for external dimmer packs.
- We urge you to ensure proper mechanical fitments of clamps and a usage of safety chains while suspending from the top.

## **FIXTURE OVERVIEW:**

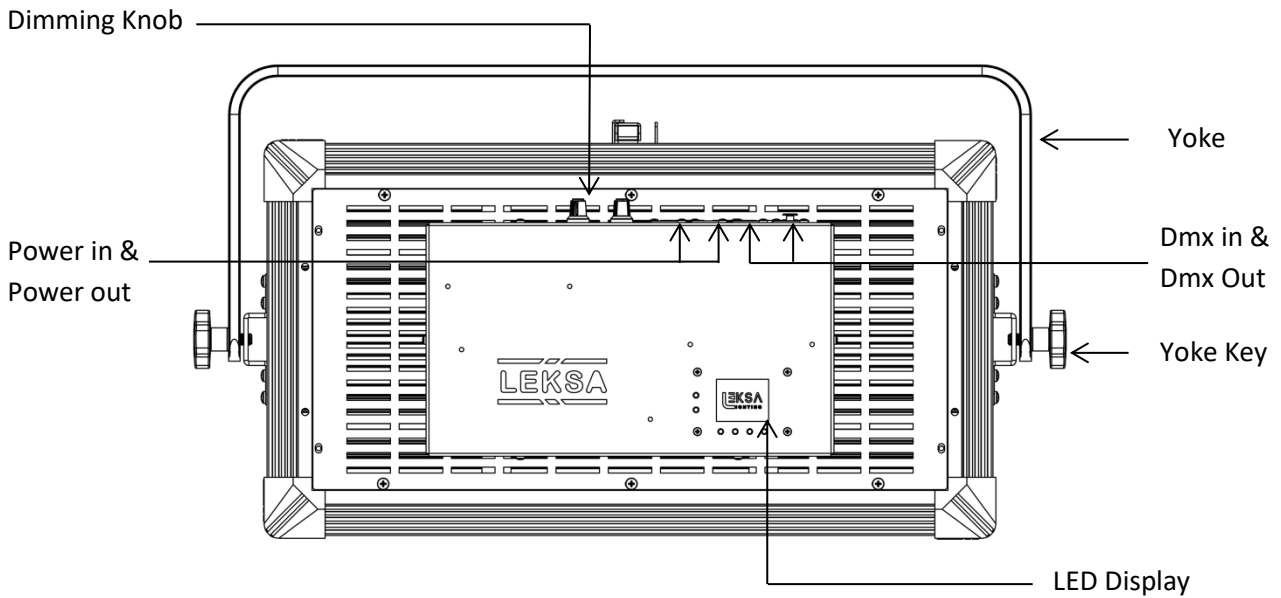

DMX Input  
5 Pin XLR Socket

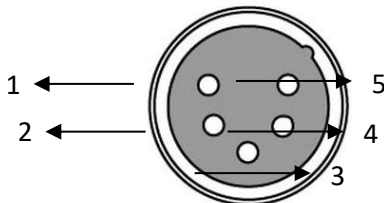

DMX Output  
5 Pin XLR Socket

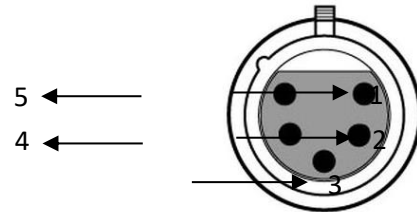

1	Ground	2	Data -	3	Data +
4	Open	5	Open		

### **Note:**

- DMX 512 Signal looping can be done from one fixture to other.
- Maximum 25 to 30 Fixtures can be taken in a single loop provided the distance is within short range.
- No Y Split is allowed for DMX looping.
- DMX last open end to be terminated with a 120 Ohm Resistor termination plug

## FIXTURE DETAILS:

Type of Fixture	:	LED LENS/SOFT PANEL
Lamp Source	:	Light Emitting Diode (LED)
Input Voltage	:	110-240V, 50-60Hz
Power Consumptions :		LED LENS/SOFT PANEL(T/D/BC) – 100W & 150W LED LENS/SOFT PANEL(T/D/BC) – 200W & 250W LED LENS/SOFT PANEL(T/D/BC) – 300W
Control Modes	:	Manual Dimming/DMX Dimming
Power Chord	:	Neutrik Power In & Loop
DMX Interface	:	5 Pin (Standard), 3 Pin (Custom)
Dimensions	:	

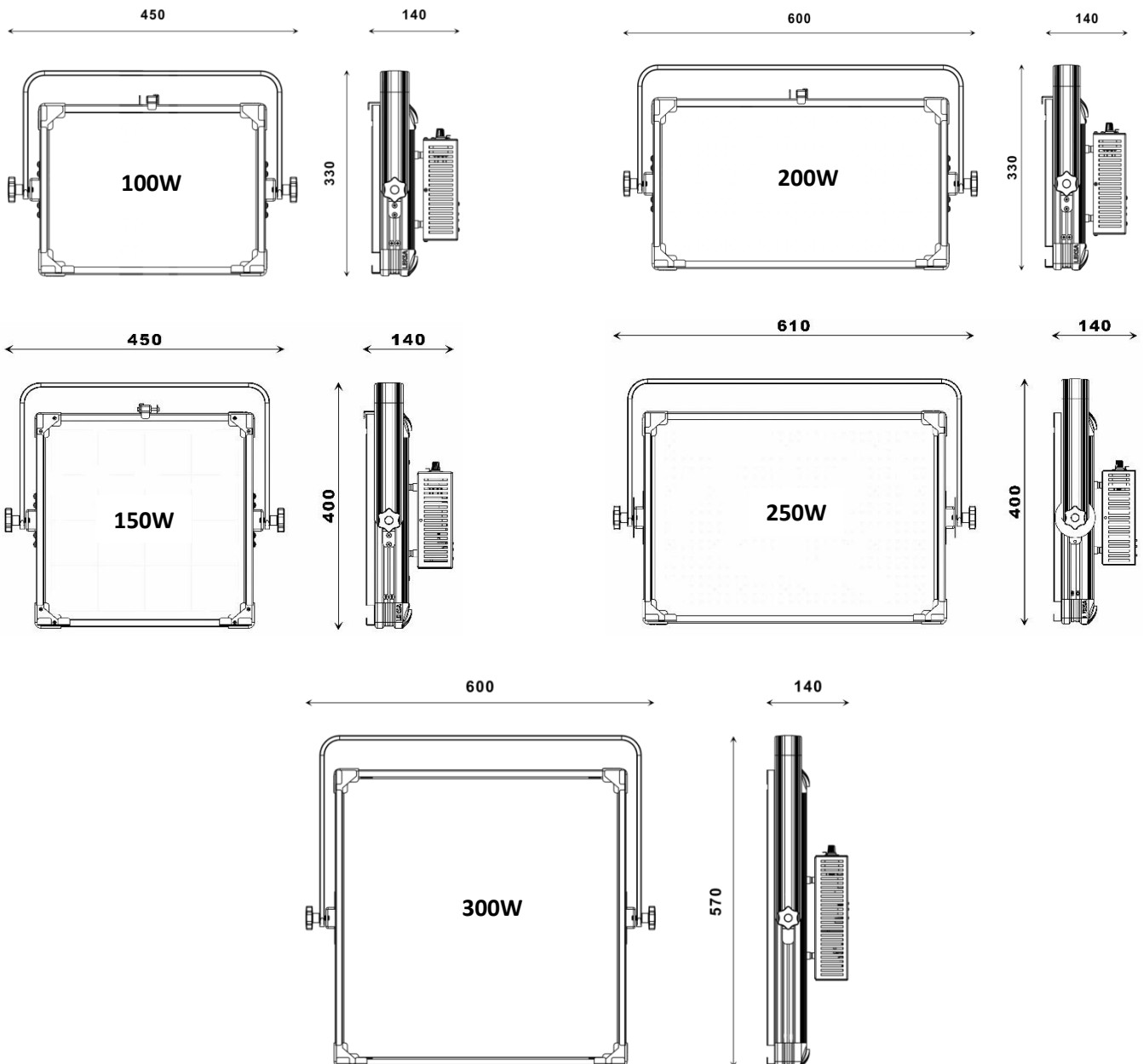

## FIXTURE OPERATION:

- Unbox the fixture and connect Power Neutrik inlet connector to the fixture to power UP.
- Switch on the Power switch, which is available in the fixture.
- There are 4 Switches – **Menu Up Down Enter**

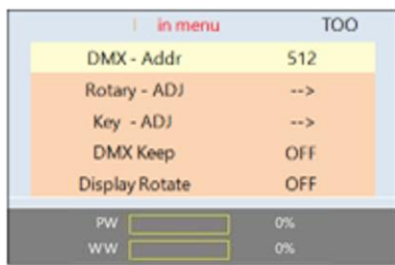

**Display-1**

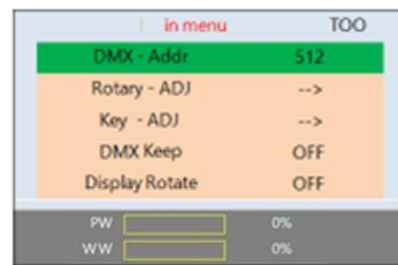

**Display-2**

- Selected Row is highlighted with Yellow (Display 1) and by pressing **Enter** you may edit the values. While **Enter** is pressed, Editing mode Row is Highlighted with Green (Display 2).
- Bi Color fixture (LCD Display) will shows the 2 channel indication and user will get 2 channel control in the DMX controller (Display 2).
- Operation using console for Bi Color explained below, Fader 1 for pure white intensity control and Fader 2 used for warm white intensity control. One channel in single color and Two channels in Bi Color is available.

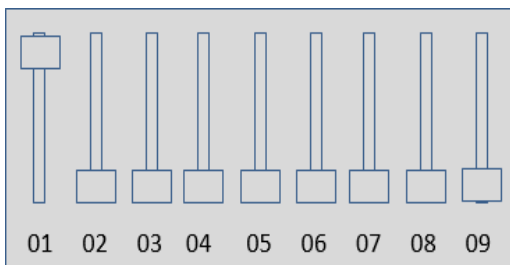

**DMX CH. 1 FOR CW**

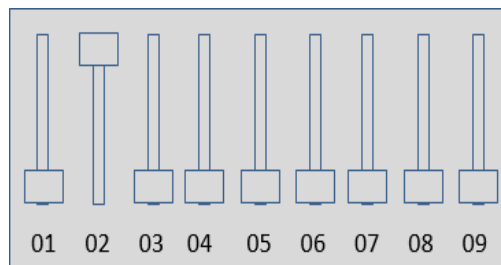

**DMX CH. 1 FOR WW**

- **Menu** button will be used for back operation to exit the editing mode or come back to the main Menu.
- **Up & Down** Keys will help you to navigate to reach other options in the menu bar.

DMX _ Address	-	To set the DmX Address.
Rotary Adjustment	-	To change the intensities quickly in Live Mode
Key Adjustment	-	Fixture Setting to Manual Dimming Mode
DmX Keep	-	To hold the last value of output on failure of DmX
Display Rotate	-	To rotate the display when fixture is tilted 180°

## FIXTURE OPERATION:

### DMX Address Setting:

Bi Color fixture (LCD Display) will shows the 2 channel indication and the user will be able to utilise the DMX controller to control the two channels as indicated below.

- Enter the **Menu** button and navigate the selection to 'DMX - Addr' and press **Enter**.
- Your selection will change to Green.

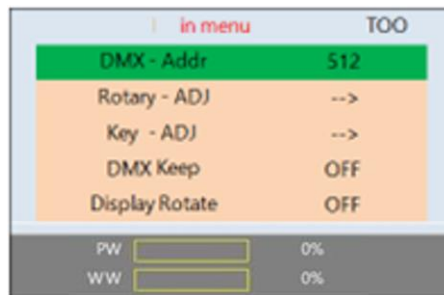

- Use **UP** & **Down** Keys to adjust the DMX Address. You may set the DMX Address between 1 ~ 512 as per DMX Protocol.
- After the address setting press **Enter** to save the value. Your display row will change the color to Yellow again as a indication of data saving. Even though a power failure after saving the address, light will retain the DMX address when it is powered up.
- You will be able to operate the light at the set address by connecting the fixture to the DMX network.

User is requested to follow the basic Notes provided in Page No. 4 regarding DmX.

### Manual Light Control:

In Manual light control, light has 2 options for controlling BI-COLOR

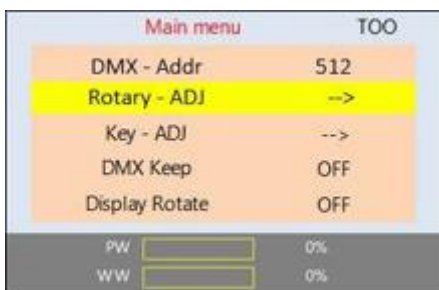

BI-COLOUR Adjustment using knob



BI-COLOUR Adjustment using keys

1. If the label is in green colour the set values will remains in same condition if power goes "OFF"

2. Yoke rotation option, Keys for tightening the handle must be highlighted somewhere.
  3. Option for inserting the accessories with locking clips need to be mentioned somewhere
- Use **UP** & **Down** Keys to adjust the intensities. Values of the light will vary proportionately 0 ~ 100% by adjusting the values from 0 ~ 255.
  - After the value setting press **Enter** to save the value. Your display row will change the color to Yellow again as a indication of data saving. Even though a power failure after saving the value, light will retain the values when it is powered up.

**Note:**

- In a DmX Mode, Light fixture will operate with 1 Channel. For a Bi Color Fixture 2 Channels will be utilized.
- CW – Stands for Cool White 5600K, WW – Stands for Warm White 3200K.
- Do NOT open the fixture for any kind of repair. There are parts which can be operated by authorized personnel's only.

For Further assistance, you are requested to contact our office or authorized dealers.  
We are there at your service.

Thank You for Choosing Leksa Lighting:

Leksa Lighting Technologies Pvt. Ltd.  
Ashwathapura Road, Moodbidri,  
Mangalore – 574227, India  
[www.leksalighting.com](http://www.leksalighting.com)  
[biz@leksalighting.com](mailto:biz@leksalighting.com)  
+91-7899 543210